

Technical sheet :

MT 930 H



Capacities		Metric
Max. capacity		3000 kg
Max. lifting height		8.85 m
Max. outreach		6.05 m
Weight and dimensions		
Overall length to carriage	l11	4.67 m
Overall length (with forks)	l1	5.77 m
Overall width	b1	1.99 m
Overall height	h17	1.99 m
Wheelbase	y	2.69 m
Ground clearance	m4	0.35 m
Overall cab width	b4	0.79 m
Tilt-up angle	a4	11 °
Tilt-down angle	a5	116 °
External turning radius (over tyres)	Wa1	3.35 m
Unladen weight (with forks)		6550 kg
Standard tyres		ALLIANCE 380/75 R20 148A8 A580
Forks length / width / section	l / e / s	1070 mm x 100 mm / 50 mm
Performances		
Lifting		10.24 s
Lowering		7.95 s
Extension		9.89 s
Retraction		9.48 s
Crowd		3.06 s
Dump		2.44 s
Engine		
Engine brand		Kubota
Engine norm		Stage V
Engine model		V3307-CR-TE5B
Number of cylinders / Capacity of cylinders		4 - 3331 cm ³
I.C. Engine power rating - Power (kW)		75 Hp / 54.60 kW
Max. torque / Engine rotation		265 Nm @ 1400 rpm
Drawbar pull (Laden)		3860 daN
Transmission		
Transmission type		Hydrostatic
Number of gears (forward / reverse)		2 / 2
Max. travel speed		24.90 km/h
Service brake		Hydraulic
Hydraulics		
Hydraulic pump type		Gear pump
Hydraulic flow / Pressure		88 l/min / 245 bar
Tank capacities		
Engine oil		11 l
Hydraulic oil		115 l
Fuel tank		90 l
Noise and vibration		
Noise at driving position (LpA)		74 dB
Noise to environment (LWA)		103 dB
Vibration on hands/ams		< 2.50 m/s ²
Miscellaneous		
Steering wheels (front / rear)		2 / 2
Safety cab homologation		Cabin ROPS - FOPS Level 2

MT 930 H - Dimensional drawing

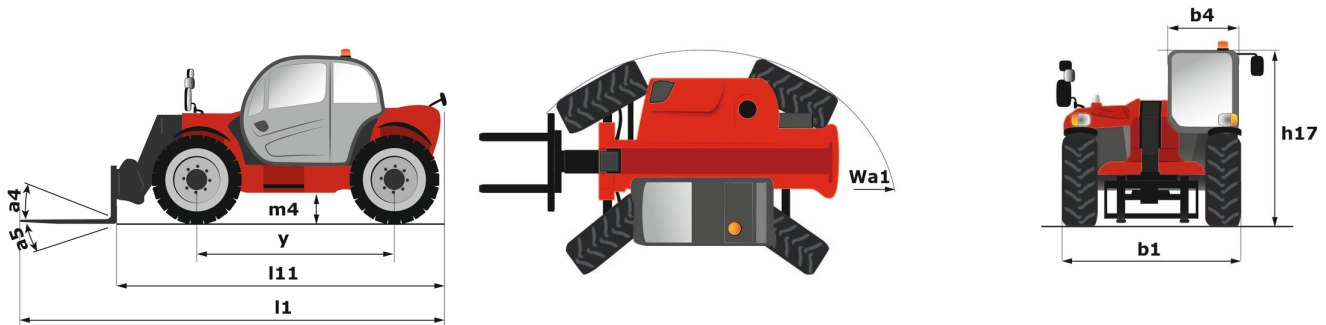

MT 930 H - Load chart

Machine on tyres with forks Metric

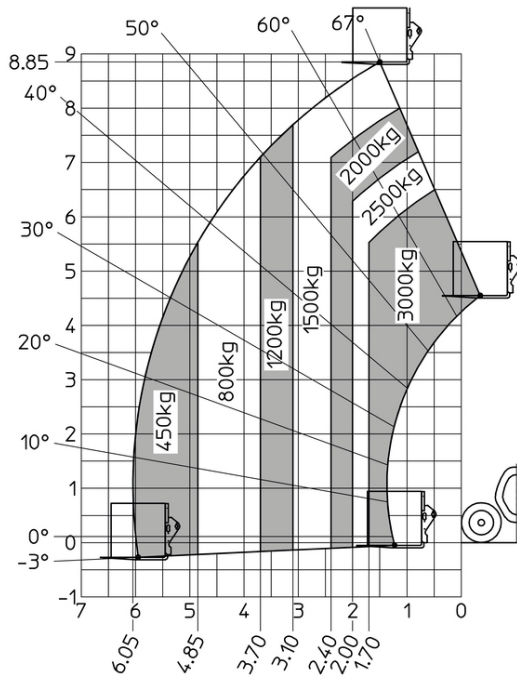



Siège Social
430 rue de l'Aubinière - 44150 Ancenis Cedex - France
Tel: +33(0)2 40 09 10 11 - Fax: +33 (0)2 40 09 10 97
www.manitou.com



This brochure describes versions and configuration options for Manitou products which may be fitted with different equipment. The equipment described in this brochure may be standard, optional or not available depending on version. Manitou reserves the right to change the specifications shown and described at any time and without prior warning. The manufacturer is not liable for the specifications given. For more information, contact your Manitou dealer. Non-contractual document. Product descriptions may differ from actual products. List of specifications is not comprehensive. The logos and visual identity of the company are the property of Manitou and may not be used without authorisation. All rights reserved. The photos and diagrams contained in this brochure are provided for information only.

MANITOU BF SA - Limited company with board of directors - Share capital: 39,668,399 euros - 857 802 508 RCS Nantes